

COPAL ELECTRONICS

SMALL SIZE
PRESSURE INDICATOR

PZ-30

CE marking
(Compliance with EMC Standard)

INSTRUCTION MANUAL Ver.3.1

**SCIENCE
GATE**
Your Automation Partner



SCIGATE AUTOMATION (S) PTE LTD

No.1 Bukit Batok Street 22 #01-01 Singapore 659592

Tel: (65) 6561 0488

Fax: (65) 6562 0588

Email: sales@scigate.com.sg

Web: www.scigate.com.sg

Business Hours: Monday - Friday 8.30am - 6.15pm

Thank you for purchasing a
NIDEC COPAL ELECTRONICS CORP. product.

In order to use the product correctly and most appropriately,
please completely read this manual before use and keep it
for future reference.



Important Information and Warnings



This caution mark describes when there is a possibility that user may suffer from damage or physical damage may occur if the product is used improperly.

- ① This product is a pressure indicator which displays the detected pressure by connecting a pressure sensor with a built-in amplifier and setting the rated pressure range of an applicable sensor. Since the product type differs according to the specifications (voltage and current signals) of each sensor, use it with appropriate combinations.
- ② The power voltage applied to this product is used as the drive voltage for the sensor connected. Therefore, make sure the power requirements of the sensor and use it within the allowable specification range.
- ⚠️③ Make cable wiring when the power is turned OFF. Be careful to mis-wiring and non-wiring, it may damage the product.
- ④ Use a stable DC power supply. For the relay, solenoid, or other inductive loads used on the same power circuit with this product, use an appropriate surge absorption element (diode, varistor, etc.) (Refer to the figure at right.)
- ⚠️⑤ The protection structure of this product conforms to IP40 of IEC standards or equivalent. The product is not suitable for use in dust- and drip-proof environments requiring higher standards. In addition, since it does not have an explosion proof structure, do not use it in flammable gases.
- ⑥ Do not pull the cable with a force of 40N or more when handling this product, as this may disconnect the cable or damage the product.
- ⑦ Do not use pointed objects such as pens to press the setting buttons on the display panel.
- ⑧ Use pH neutral detergents to clean the housing of this product. Do not use thinners or other solvents.

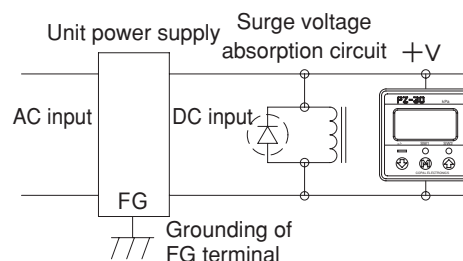

For more detailed information please ask for the nearest distributor or the following sales center.

COPAL ELECTRONICS

Nishi-Shinjuku Kimuraya Bidg., 7-5-25

Nishi-Shinjuku Shinjuku-ku Tokyo 160-0023, Japan Phone.: (03) 3364-7055

Specifications

| | | |
|----------------------|---------------------------------------------------------------------------------------------------------------|------------------------------------------------------------------------------------------------|
| Sensor input signal | 1~5V type (V type) / 4~20mA (I type) | |
| Sensor connection | ST: Terminal board type, Osada ONC-051 (one-touch type) CN: Connector type, AMP 0-171826 (pin-header type) | |
| Power voltage | 10.8~30VDC (including ripple) | |
| Current consumption | 50mA or less | |
| Pressure display | Full 3 digit LED display (sampling cycle: 4 times per second) | |
| | Negative pressure display | (±) Red LED is lit |
| | Display accuracy | ±1%FS (not including sensor errors) |
| | Temperature characteristic | ±0.5%FS (0-50 C, at 25 °C) |
| Switch outputs | 2 outputs, NPN/PNP transistor open collector | |
| | Switch capacity | 30VDC 100mA or less |
| | Residual voltage | 1.2V or less (NPN) / 2.2V or less (PNP) |
| | Hysteresis | 0~300counts (variable) |
| | Repeatability | ±0.2%FS |
| | Short circuit | protection Provided |
| | Response | Approx.5ms (digital filter setup: F-0) |
| | Temperature | ±0.5%FS (0-50 C, at 25 °C) |
| Operation display | Output 1 (green LED) and Output 2 (red LED) light up when outputs are ON. | |
| Analog output | Voltage output of sensor input signal: 1~5V | |
| Operating conditions | IP protection | IP40 |
| | Operating temperature | -10~50°C |
| | Operating humidity | 35~85%RH |
| | Insulation resistance | 100M ohms or more between bundled leads and chassis at 500VDC |
| | Dielectric strength | Between bundled leads and chassis at 500VAC for one minute |
| | Vibration resistance | 10-500Hz, 1.5mm amplitude / 98.1 ^m /s ² , three directions, 2 hours each |
| | Shock resistance | 490 ^m /s ² , three direction, three times each |
| | E M C | EMI : EN55011 (Group1、ClassB) : 1998 EMS : EN61326-1 : 1997/A1 : 1998 |
| Housing material | Chassis: ABS/PC | |
| Net weight | Approx. 80g (including 2m cable) | |
| Accessories | Unit Sticker (kPa, MPa) | |

Model numbers

P Z - 3 0 - N V S T I
 ① ② ③ ④

- | | |
|------------------------------------------------------------------------------------------------|-------------------------------------------------------------------------------------------------------------------------------------|
| ① Switch output type N : NPN transistor open collector P : PNP transistor open collector | ③ Sensor connection type S T : One-touch type terminal (Osada make OCN-051) C N : Connector type terminal (AMP make 171826-3) |
| ② Input signal type V : V type 1~5V I : I type 4~20mA | ④ Analog output Blank : Voltage output I : Current output |

Operation Panel

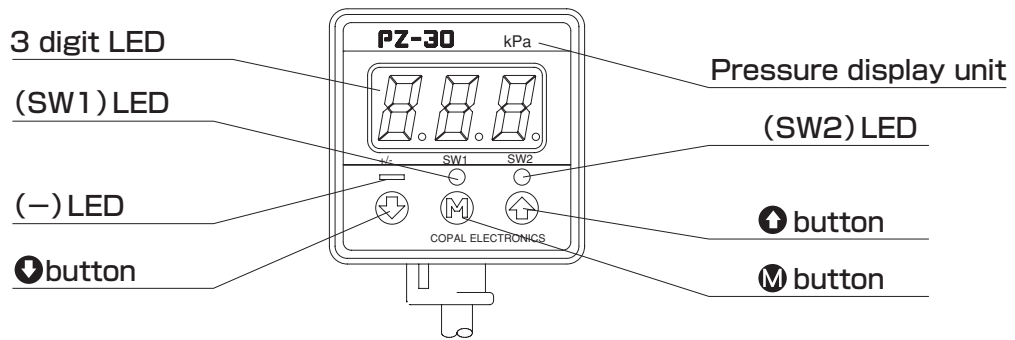

Initial LED Display (About 3 Seconds)

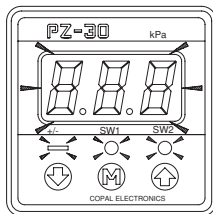

All LEDs flash twice.

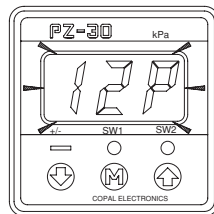

The Rated Pressure Setting code flashes.

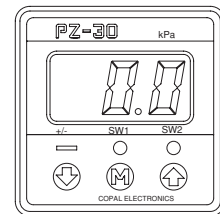

The Operations Mode (pressure detection) is activated.

Input/Output Circuit Diagrams (Wire Colors Conform to IEC Standards)

<Voltage analog output>

• NPN switch output / Analog voltage output type

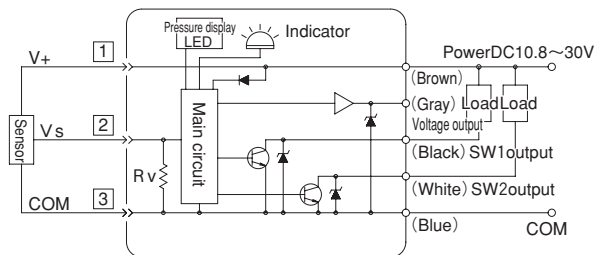

• PNP switch output / Analog voltage output type

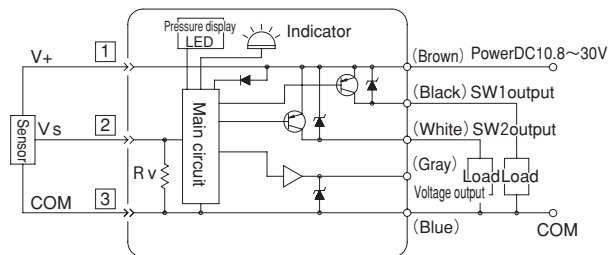

<Current analog output>

• NPN switch output / Analog current output type

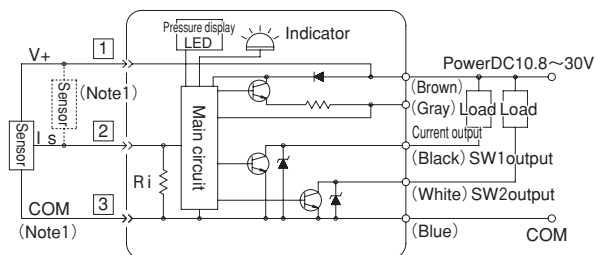

• PNP switch output / Analog current output type

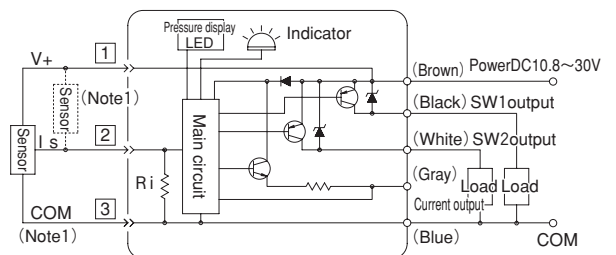

(Note1) 2-wire current output sensor
Input Resistance (R_i): 250 Ω

Operating Procedure

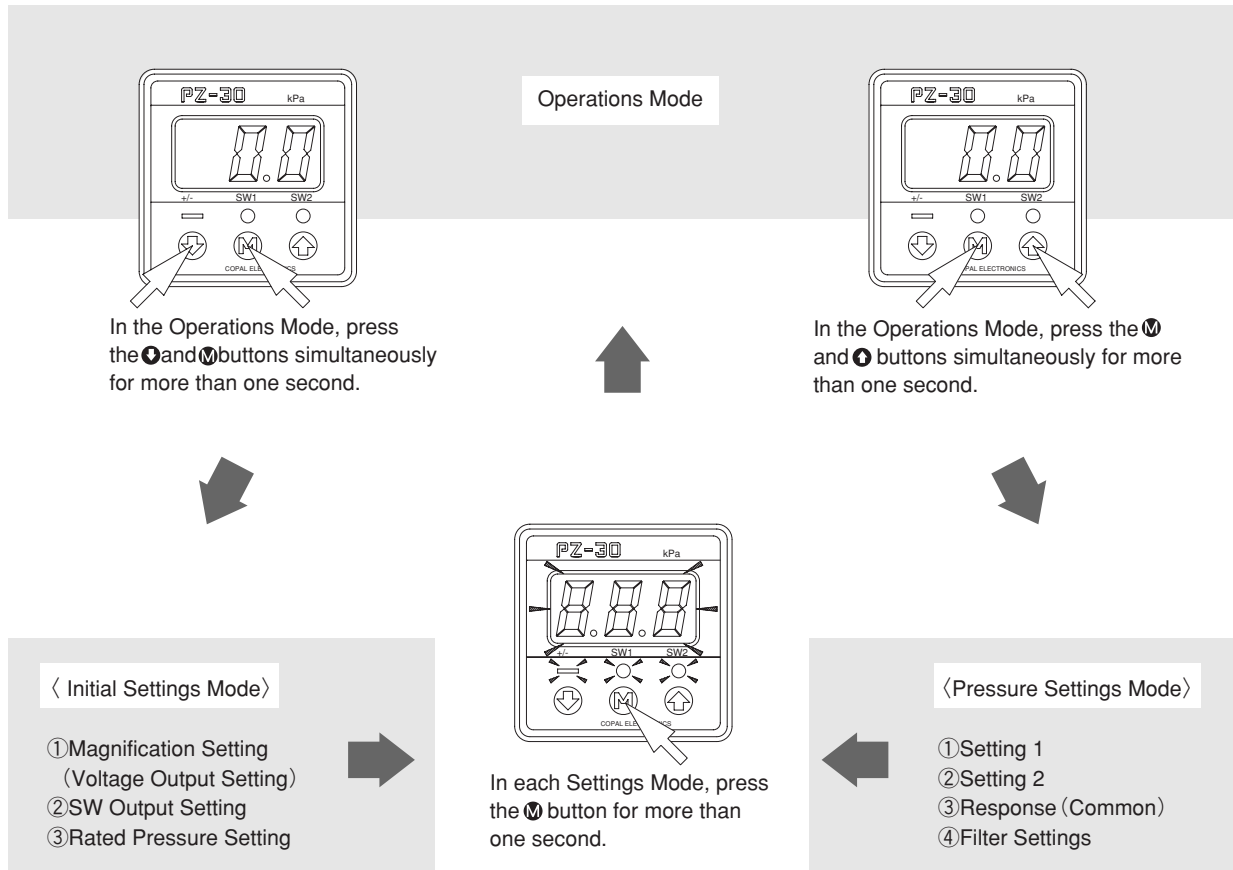

Initial Settings Mode/Setting Procedure (When changing the rated pressure, perform ③ Rated Pressure Setting first.)

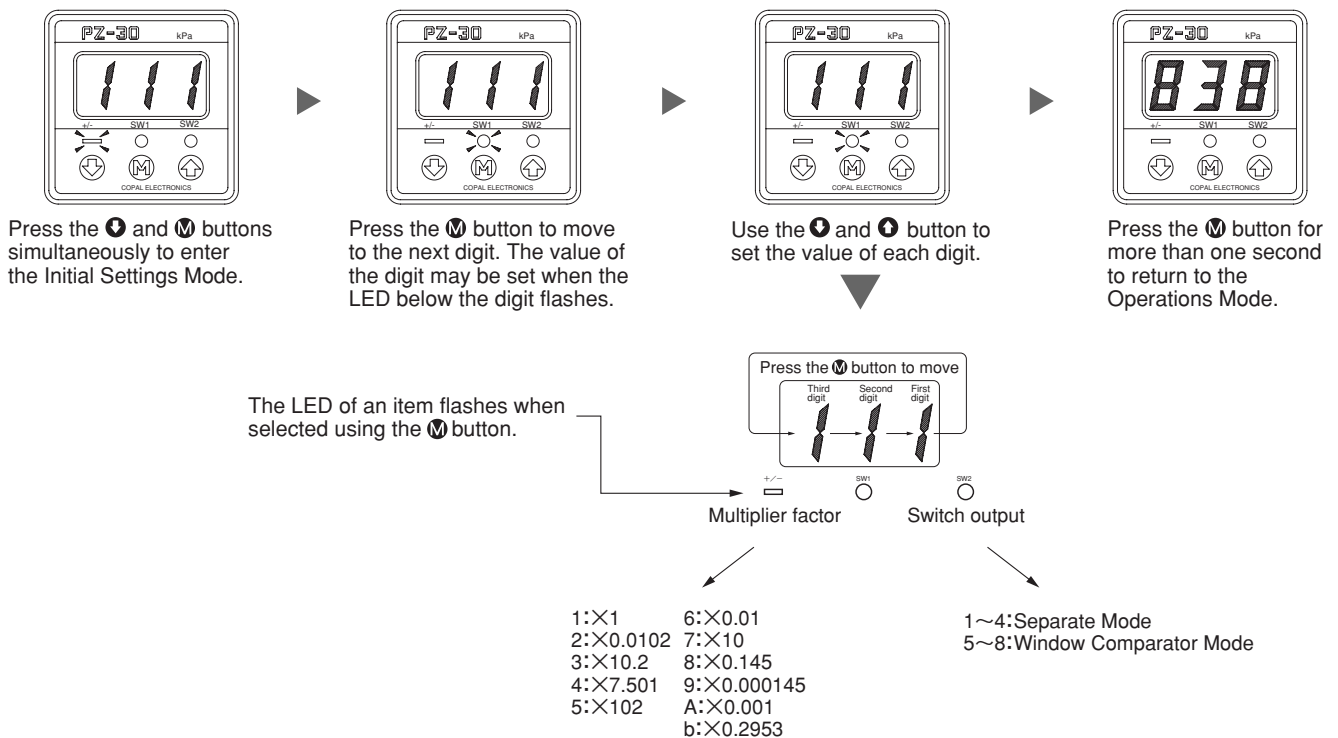

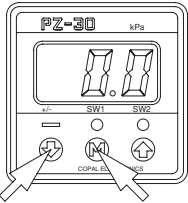

In the Operations Mode, press the **-** and **M** buttons simultaneously for more than one second.

Notes

- ③ If the Rated Pressure Setting code is operated, the codes set in ① and ② are initialized automatically for each rated pressure range. Therefore, if ③ Rated Pressure Setting is made first, do not operate this code.
- ② If SW Output Setting is changed and, in particular, the mode is switched between the Separate and Window Comparator Modes, note that Setting 1, Setting 2, and Hysteresis set in other modes (Pressure Settings Mode) are changed automatically if inconsistent operation is expected.

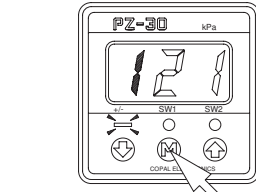

The (-) LED flashes to notify the Magnification Settings Mode. First, enter the Rated Pressure Settings Mode. Press the **M** button twice to skip two Settings Modes. Press this button for more than one second to establish all settings and return to the Operations Mode. Hereinafter, operate the **M** in the same manner as above.

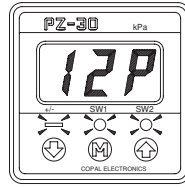

The (-), (SW1), and (SW2) LEDs flash to notify the Rated Pressure Settings Mode. The "12P" display on the 3 digit LED indicates the value at the time of shipment: 0 to 100kPa. Operate the **-** or **+** button to select the setting code which is equivalent to the rated pressure of the external sensor.

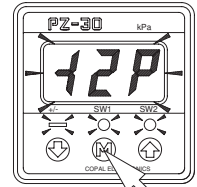

In this example, "-12P": 0 to -100kPa is selected and the LED flashes to indicate that it can be changed. When the **M** button is operated to proceed with the next Settings Mode, the Rated Pressure Setting is established.

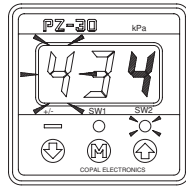

② The (SW2) LED flashes to notify the SW Output Settings Mode. The 3 digit LED indicates "4": L/L Operation. Operate the **-** or **+** button to select the SW Output Operation code. In this case, the L/L Operation remains unchanged. Operate the **M** button to return to the next Settings Mode ③, or establish all settings and return to the Operations Mode.

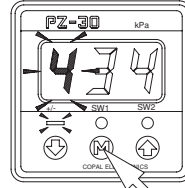

In this example, "4": 0 to -750 is selected and the LED flashes to indicate that it can be changed. Operate the **M** button to proceed with the next Settings Mode. (The 2nd digit of the 3 digit LED indicates the Voltage Output Setting which is fixed for each rated pressure.)

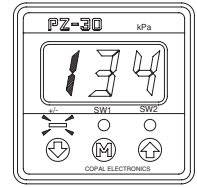

① The (-) LED flashes to notify the Magnification Settings Mode. The 3rd digit of the 3 digit LED indicates "1": kPa. (Refer to the following examples.) Operate the **-** or **+** button to select the Magnification Setting code.

Voltage Output Operation

| Voltage Output Setting | | 0 | | |
|------------------------|-------------------------------|-----------|------------|-------------|
| Code | Output mode | -Pr | | +Pr |
| "1" | R mode (compound pressure) | 1V (4mA) | → (Vz) | → 5V (20mA) |
| "2" | G mode (positive pressure) | | → 1V (4mA) | → 5V (20mA) |
| "3" | V mode (negative pressure) | 5V (20mA) | ← 1V (4mA) | |

SW Output Setting / Operation Diagram

| Output Mode | SW1 output | | | | SW2 output | | | |
|-------------|------------|----------------------------------------------------|----------|-------------------|----------------------------------------------------|-------------------|----------|-------------------|
| | Separate | Window Comparator | Separate | Window Comparator | Separate | Window Comparator | Separate | Window Comparator |
| Operation | H | L | A | B | H | L | A | B |
| 1 | ○ | | | | ○ | | | |
| 2 | ○ | | | | | ○ | | |
| 3 | | ○ | | | | ○ | | |
| 4 | | | ○ | | | | ○ | |
| 5 | | | | ○ | | | | ○ |
| 6 | | | ○ | | | | ○ | |
| 7 | | | | ○ | | | | ○ |
| 8 | | | | ○ | | | | ○ |
| | Setting1 | Lower limit : Setting 1 Upper limit : Setting 2 | | Setting2 | Lower limit : Setting 1 Upper limit : Setting 2 | | | |
| | Note 1 | Note 2 | Note 1 | Note 2 | | | | |

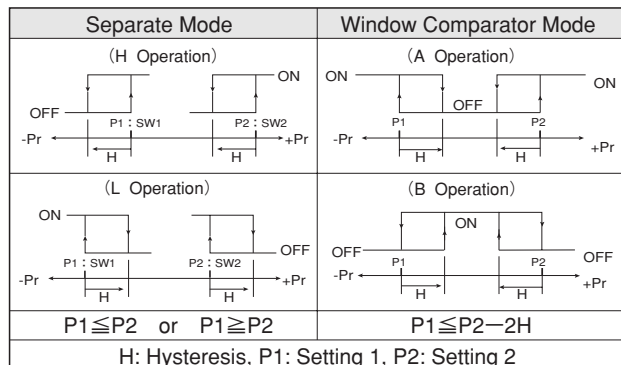

Note1. In the Separate Mode, setting 1 corresponds to SW1, and Setting 2 corresponds to SW2.

Note2. In the Window Comparator Mode, the minimum value for SW1 and SW2 corresponds to Setting1 and the maximum value corresponds to Setting 2.

Magnification Setting / Rated Pressure Setting

| Mode (1/3) | | Indication method | Gauge / absolute pressure | | | | | | | | | | | |
|-----------------------|----------------------|----------------------------------------------------------|---------------------------|--------------|--------------|---------------|--------------|--------------|--------------|--------------|--------------|--------------|--------------|----------|
| | | Pressure unit | kPa | | | | | | | | | | MPa | |
| Magnification Setting | Rated pressure range | Setting code | 0~10 | 0~35 | 0~50 | 0~-100 | 0~100 | 0~350 | 0~500 | 0~600 | 0~700 | 0~1000 | 0~2.00 | |
| Code | Magnification | Setting code | "11P" | "41P" | "51P" | "-12P" | "12P" | "42P" | "52P" | "62P" | "72P" | "13P" | "23P" | |
| "1" | ×1 (kPa) | Rated pressure display (P _L ~P _H) | 0.00 9.99 | 0.0 35.0 | 0.0 50.0 | 0.0 -99.9 | 0.0 99.9 | 0 350 | 0 500 | 0 600 | 0 700 | 0 999 | 0 20.4 | |
| "2" | ×0.0102 | | 0.00 0.10 | 0.00 0.35 | 0.00 0.51 | 0.00 -1.02 | 0.00 1.02 | 0.00 3.57 | 0.00 5.10 | 0.00 6.12 | 0.00 7.14 | 0.00 9.99 | 0.00 20.4 | |
| "3" | ×10.2 | | 0.0 99.9 | 0 357 | 0 510 | 0 -999 | 0 999 | | | | | | | |
| "4" | ×7.501 | | 0.0 75.0 | 0 262 | 0 375 | 0 -750 | 0 750 | | | | | | | |
| "5" | ×102 | | 0 999 | | | | | | | | | | | |
| "6" | ×0.01 | | 0.00 0.10 | 0.00 0.35 | 0.00 0.50 | 0.00 -1.00 | 0.00 1.00 | 0.00 3.50 | 0.00 5.00 | 0.00 6.00 | 0.00 7.00 | 0.00 9.99 | 0.00 20.0 | |
| "7" | ×10 | | 0.0 99.9 | 0 350 | 0 500 | 0 -999 | 0 999 | | | | | | | |
| "8" | ×0.145 | | 0.00 1.45 | 0.00 5.07 | 0.00 7.25 | 0.0 -14.5 | 0.0 14.5 | 0.0 50.7 | 0.0 72.5 | 0.0 87.0 | 0 101 | 0 145 | 0 290 | |
| "9" | ×0.000145 | | | | | | | | | | | | 0.00 0.29 | |
| "A" | ×0.001(MPa) | | | | | | | | | | | | 0.00 1.00 | |
| "b" | ×0.2953 | | | 0.00 2.95 | 0.0 10.3 | 0.0 14.7 | 0.0 -29.5 | 0.0 29.5 | 0 103 | 0 147 | 0 177 | 0 206 | 0 295 | 0 590 |

| Mode (2/3) | | Indication method | Gauge / absolute pressure | | | | | Gauge (Compound) pressure | | | | | | |
|-----------------------|----------------------|----------------------------------------------------------|---------------------------|--------------|--------------|--------------|--------------|---------------------------|---------------|---------------|---------------|---------------|---------------|---------------|
| | | Pressure unit | MPa | | | | | kPa | | | | | | |
| Magnification Setting | Rated pressure range | Setting code | 0~3.50 | 0~5.00 | 0~10.0 | 0~20.0 | 0~35.0 | -10~10 | -100~100 | -100~200 | -100~300 | -100~500 | -100~600 | -100~1000 |
| Code | Magnification | Setting code | "43P" | "53P" | "14P" | "24P" | "44P" | "11r" | "12r" | "22r" | "32r" | "52r" | "62r" | "13r" |
| "1" | ×1 (kPa) | Rated pressure display (P _L ~P _H) | | | | | | -9.99 9.99 | -99.9 99.9 | -100 200 | -100 300 | -100 500 | -100 600 | -100 999 |
| "2" | ×0.0102 | | 0.0 35.7 | 0.0 51.0 | 0 102 | 0 204 | 0 357 | -0.10 0.10 | -1.02 1.02 | -1.02 2.04 | -1.02 3.06 | -1.02 5.10 | -1.02 6.12 | -1.02 9.99 |
| "3" | ×10.2 | | | | | | | -99.9 99.9 | -999 999 | | | | | |
| "4" | ×7.501 | | | | | | | -75.0 75.0 | -750 750 | | | | | |
| "5" | ×102 | | | | | | | -999 999 | | | | | | |
| "6" | ×0.01 | | 0.0 35.0 | 0.0 50.0 | 0.0 99.9 | 0 200 | 0 350 | -0.10 0.10 | -1.00 1.00 | -1.00 2.00 | -1.00 3.00 | -1.00 5.00 | -1.00 6.00 | -1.00 9.99 |
| "7" | ×10 | | | | | | | -99.9 99.9 | -999 999 | | | | | |
| "8" | ×0.145 | | 0 507 | 0 725 | 0.00 1.45 | 0.00 2.90 | 0.00 5.07 | -1.45 1.45 | -14.5 14.5 | -14.5 29.0 | -14.5 43.5 | -14.5 72.5 | -14.5 87.0 | -14 145 |
| "9" | ×0.000145 | | 0.00 0.50 | 0.00 0.72 | 0.00 1.45 | 0.00 2.90 | 0.00 5.07 | | | | | | | -0.01 0.14 |
| "A" | ×0.001(MPa) | | 0.00 3.50 | 0.00 5.00 | 0.00 9.99 | 0.0 20.0 | 0.0 35.0 | | -0.10 0.10 | -0.10 0.20 | -0.10 0.30 | -0.10 0.50 | -0.10 0.60 | -0.10 1.00 |
| "b" | ×0.2953 | | 0 999 | | | | | -2.95 2.95 | -29.5 29.5 | -29.5 59.0 | -29.5 88.5 | -29 147 | -29 177 | -29 295 |

| Mode (3/3) | | Indication method | Gauge / absolute pressure | | | | | | | | | |
|-----------------------|----------------------|----------------------------------------------------------|---------------------------|--------------|--------------|---------------|--------------|--------------|--------------|--------------|--------------|----------|
| | | Pressure unit | (×1/0.0102) kPa | | | | | | | | | |
| Magnification Setting | Rated pressure range | Setting code | 0~0.10 | 0~0.035 | 0~0.050 | 0~-1.00 | 0~1.00 | 0~3.50 | 0~5.00 | 0~7.00 | 0~10.0 | |
| Code | Magnification | Setting code | "11F" | "41F" | "51F" | "-12F" | "12F" | "42F" | "52F" | "72F" | "13F" | |
| "1" | ×1 (kPa) | Rated pressure display (P _L ~P _H) | 0.00 9.80 | 0.0 34.3 | 0.0 49.0 | 0.0 -98.0 | 0.0 98.0 | 0 343 | 0 490 | 0 686 | 0 980 | |
| "2" | ×0.0102 | | 0.00 0.10 | 0.00 0.35 | 0.00 0.50 | 0.00 -1.00 | 0.00 1.00 | 0.00 3.50 | 0.00 5.00 | 0.00 7.00 | 0.00 9.99 | |
| "3" | ×10.2 | | 0.0 99.9 | 0 350 | 0 500 | 0 -999 | 0 999 | | | | | |
| "4" | ×7.501 | | 0.0 73.5 | 0 257 | 0 367 | 0 -735 | 0 735 | | | | | |
| "5" | ×102 | | 0 999 | | | | | | | | | |
| "6" | ×0.01 | | 0.00 0.09 | 0.00 0.34 | 0.00 0.49 | 0.00 -0.98 | 0.00 0.98 | 0.00 3.43 | 0.00 4.90 | 0.00 6.86 | 0.00 9.80 | |
| "7" | ×10 | | 0.0 98.0 | 0 340 | 0 490 | 0 -980 | 0 980 | | | | | |
| "8" | ×0.145 | | 0.00 1.42 | 0.00 4.97 | 0.00 7.10 | 0.0 -14.2 | 0.0 14.2 | 0.0 49.7 | 0.0 71.0 | 0.0 99.5 | 0 142 | |
| "9" | ×0.000145 | | | | | | | | | | | |
| "A" | ×0.001(MPa) | | | | | | | | | | 0.00 0.98 | |
| "b" | ×0.2953 | | | 0.00 2.89 | 0.0 10.1 | 0.0 14.4 | 0.0 -28.9 | 0.0 28.9 | 0 101 | 0 144 | 0 202 | 0 289 |

Pressure Settings Mode/Setting Procedure (Perform ② SW Output Setting in the Initial Settings Mode first.)

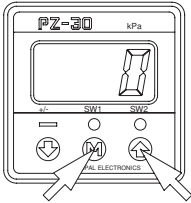

In the Operations Mode, press the M and +/- buttons simultaneously for more than one second.

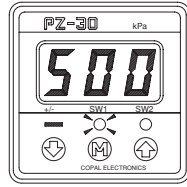

① The (SW1) LED flashes to notify the Setting 1 Settings Mode. In this example, the Magnification Setting is "4": 0 to -750. Setting 1 indicates -500 using the 3 digit LED and the (-) LED. Operate the +/- or M button to set a desired value. Press and hold the +/- or M button to increase the change rate of the number in incremental steps. The (-) LED indicates the minus sign.

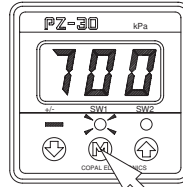

In this example, Setting 1 is set to -700. Press the M button to proceed with the next Settings Mode. Press this button for more than one second to establish all settings and return to the Operations Mode. Hereinafter, operate the M button in the same manner as above.

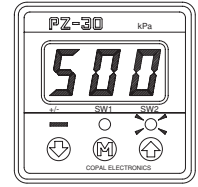

② The (SW2) LED flashes to notify the Setting 2 Settings Mode. In the same manner, Setting 2 is set to -500. Operate the +/- or M button to set Setting 2 to a desired value.

Notes

1. Perform ② SW Output Setting of the Initial Settings Mode first. In particular, if the mode is switched between the Separate and Window Comparator Modes, note that Setting 1, Setting 2, and Hysteresis set in the Pressure Settings Mode are changed automatically if inconsistent operation is expected.

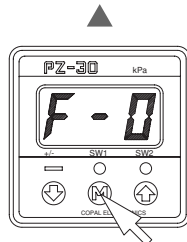

④ The LEDs stop flashing. The 3 digit LED indicates "F-*" to notify the Digital Filter Settings Mode. In this example, the response (5 msec) of "F-0" is set. Operate the +/- or M button to set the Filter Setting code (F-0, 1, 2, or 3). In this example, operate the M button without changing the setting to return to Settings Mode ①, or establish all settings and return to the Operations Mode.

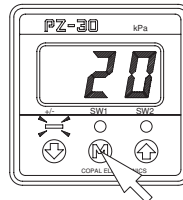

③ The (-) LED flashes to notify the Hysteresis Settings Mode. The "20" on the 3 digit LED indicates that unsigned 20 is set. Operate the +/- or M button to set the Hysteresis to a desired value from 0 to 300 counts. In this example, operate the M button to proceed with the next Settings Mode without changing the Hysteresis setting.

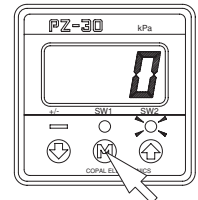

In this example, Setting 2 is set to 0. Operate the M button to proceed with the next Settings Mode.

<SW Output Settings/Pressure Setting>

- * SW Operation Pressure Settings (Setting 1/Setting 2) : Set this value when each of the (SW1) and (SW2) LEDs flashes in the Pressure Settings Mode.
- * Both Setting 1 and Setting 2 are set to 500 counts regardless of the decimal point at the time of shipment. However, for the negative pressure sensor (with the rated pressure set to -12P and -12F), they are set to -500 counts. They can be set to a range from -999 to 999 counts and the position of the decimal point is determined by the Rated Pressure and Magnification Settings.
- Note: In the Window Comparator Mode for SW Output Setting, the setting ranges of Settings 1,2 (P1,P2) and Hysteresis (H) are limited because of the conditional expression $P1 \leq P2 - 2H$, therefore it is necessary to change the order of Setting 1 or 2 so that the limitation is not applied.

<SW Output Settings/Hysteresis Setting>

- * SW Operation Pressure Settings (Hysteresis) : Set this value when the (-) LED flashes in the Pressure Settings Mode.
- * Hysteresis is set to 20 counts regardless of the decimal point at the time of shipment. This value can be set to a range from 0 to 300 counts and the position of the decimal point is determined by the Rated Pressure and Magnification Settings.
- Note: In the Window Comparator Mode for SW Output Setting, the setting ranges of Settings 1,2 (P1,P2) and Hysteresis (H) are limited because of the conditional expression $P1 \leq P2 - 2H$, therefore it is recommended that Hysteresis is set to 0 first, Setting 1 and Setting 2 are set, then Hysteresis is reset to a desired value.

<Digital Filter Setting>

- * Digital Filter Setting : Set this value when none of the (-), (SW1), and (SW2) LEDs flashes and the 3 digit LED indicates "F-*" in the Pressure Settings Mode.
- * Digital Filter Setting is set to "F-0" at the time of shipment, so that filter processing is not performed for a sampling rate of 5 msec. Four filter levels (F-0, 1, 2, and 3) can be selected which correspond to a response time of 5, 25, 250, and 2500 msec., respectively. Use filter processing if the detected pressure has instantaneous variation which is undesirable for control.
- Note: In the filter processing for this product, the running average is obtained for sampling data with 5 msec. sampling rate and then SW Output is tested at each response time of each filter.

Zero-Adjustment Procedure

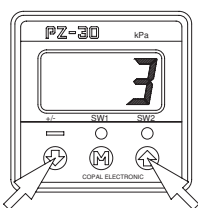

Release the pressure of the pressure port, then press the +/- and M buttons simultaneously for more than one second in the Operations Mode.

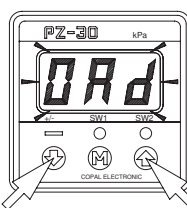

When "0Ad" flashes on the 3 digit LED, release the buttons. The zero-adjustment processing is started.

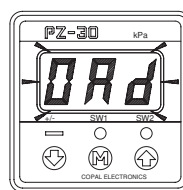

"0Ad" flashes and the zero-adjustment processing is completed in about one second. If the residual pressure is 10%FS or more, error display "E-2" results.

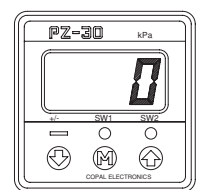

Zero is displayed and the Operations Mode is re-entered. The voltage output is not associated.

Error and Special Codes

■ If the following error messages are displayed, follow the procedures in the table.

| Error message | Description | Solution |
|--------------------------------|---------------------------------------------------------------------------------------------------------------------------------------------------|--------------------------------------------------------------------------------------------------------------------------------------------------|
| E - 1 | The load current flows in SW. The (SW1) or (SW2) LED flashes to notify the overloaded condition and both SW1 Output and SW2Output are turned OFF. | Turn OFF the power and then check the load condition. |
| E - 2 | Pressure (residual pressure, etc.) is applied at the time of zero-adjustment. | Press the M button for more than one second to cancel E-2. Release the pressure of the pressure port and then make zero adjustment again. |
| E - 3 | Setting data may be lost. | Turn ON the power again and then check Initial Settings and Pressure Settings. Also check power voltage variation, rise time, and surge voltage. |
| E - 4 | The memory may be in disorder. | There might be some problem in power start-up. Do not operate any button and re-start the power. |
| 999Flashing | Pressure values exceed the display range. | Normal state |
| Flashing of the pressure value | Pressure values exceed the rated pressure range. (110%FS) | Normal state |
| Black out of the display | Non-display mode | Normal state (See Non-display mode.) |
| Disable the key operation | Key protection mode | Normal state (See Non-display mode.) |

Others

<Non-Display Mode>

○ Non-Display [Temporary] Mode

- When the keys are not operated for more than 10 seconds during Operation Mode, the system will automatically select Non-Display [Temporary] Mode and the display will turn off.
- Decimal point LED shown in the figure below will blink during Non-Display [Temporary] Mode.
- Using the EEPROM, the PZ-30 series can retain preset values even if the power is turned off.
- If an error message is detected, the display will come back and show the error message.
- You can change any functions during Non-Display [Temporary] Mode.
- When you set Non-Display [Full-time] during Non-Display [Temporary] Mode, the mode change Non-Display [Full-time] Mode.

(How to set)



- To enable Non-Display [Temporary] Mode, press **M** key for more than 4 seconds. **50F** will be displayed and Non-Display [Temporary] Mode will be set. After 10 seconds, display will go off.
- To disable Non-Display [Temporary] Mode, press **M** key for more than 4 seconds. **L0n** will be displayed and Non-Display [Temporary] Mode will be canceled.

○ Non-Display [Full-time] Mode

- In Non-Display [Full-time] Mode, the display will be turned off and the Keys will be locked.
- Decimal point LED shown in the figure below will light up during Non-Display [Full-time] Mode.
- Using the EEPROM, PZ-30 series can retain the preset values even if the power is turned off.
- If an error message is detected, the display will come back and show the error message.
- You cannot change any functions during Non-Display [Full-time] Mode.

(How to set)

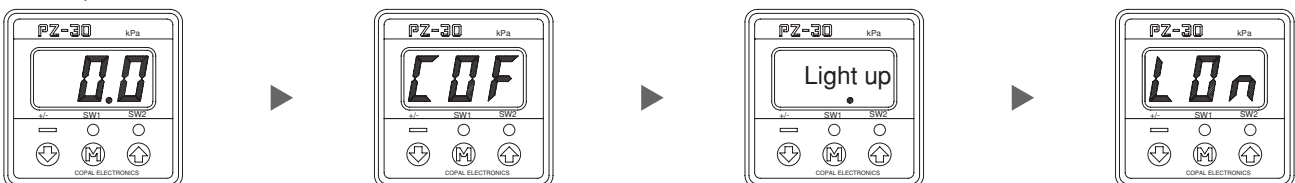

- To enable Non-Display [Full-time] Mode, press **M** key for more than 4 seconds. **COF** will be displayed and Non-Display [Full-time] Mode will be set. Display will turn off in a second.
- To disable Non-Display [Full-time] Mode, press **M** key for more than 4 seconds. **L0n** will be displayed and Non-Display [Full-time] Mode will be canceled.

<Key Protection Mode>

○Key protection Mode

- Key Protection Mode is used to lock the front panel key in order to prevent preset values from being accidentally changed.
- Using EEPROM,the PG-30/35 series can retain the preset values even if the power is turned off.

(How to set)

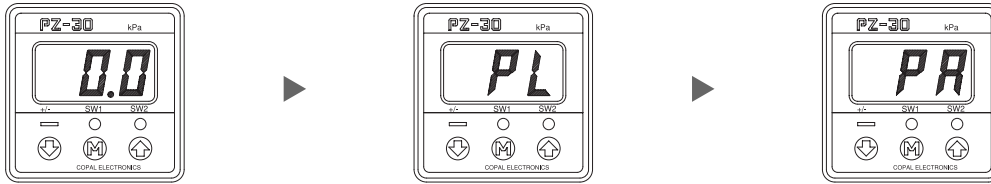

- To enable key Protection Mode,press **⏏** key for more than 4 seconds. **PL** will be displayed and the keys will be locked.
- To disable key Protection Mode,press **⏏** key for more than 4 seconds. **PR** will be displayed and the keys will be unlocked.

<Caution of attachment>

- If mounting with an angled bracket, the maximum torque of the M3 screws should be less than 0.3N—m.
- If mounting with an Panel holder set, do not apply excessive force.

Outline Dimensions (Unit:mm)

Terminal board type

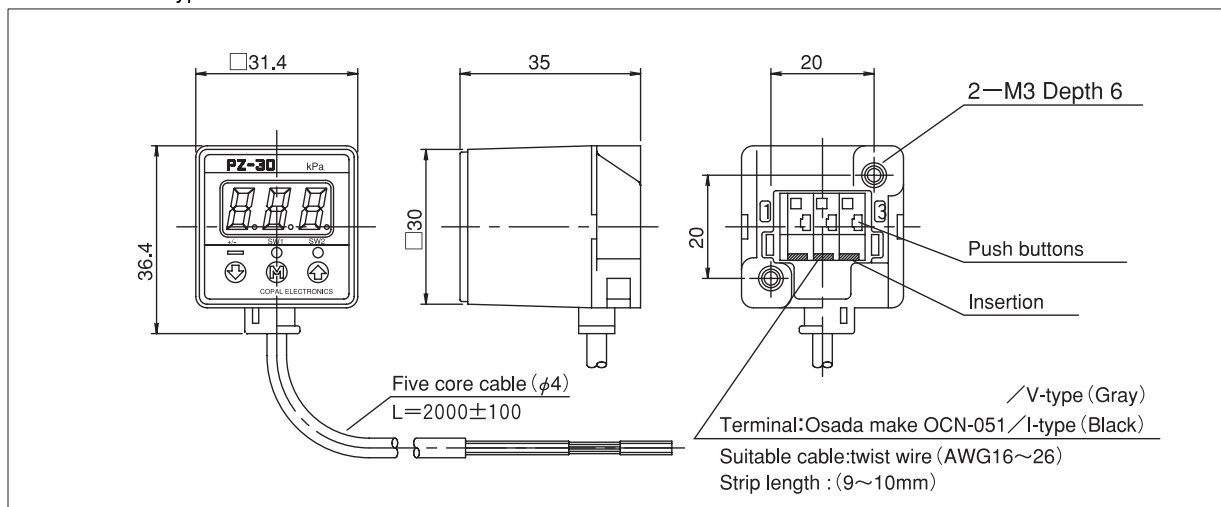

Connector type

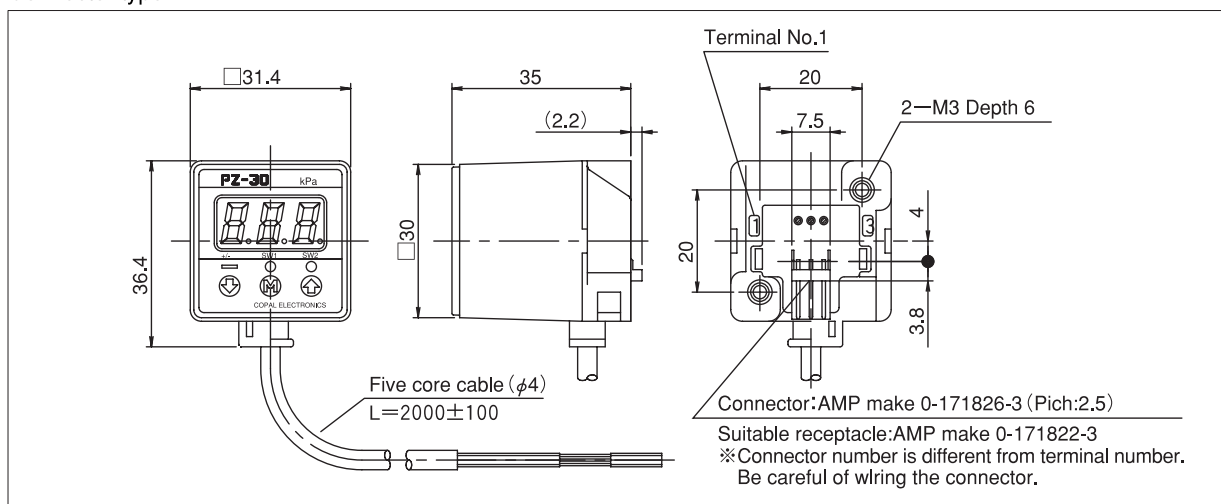

Attachment

<Angled brackets>

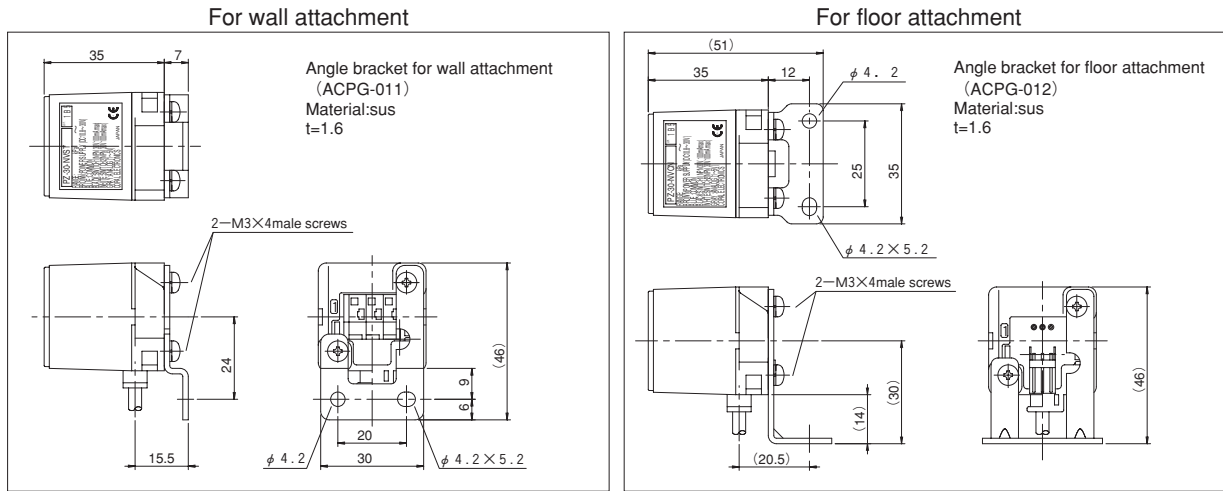

<Panel mount>

Panel holder set / holder cover set / holder stopper set (sold separately)

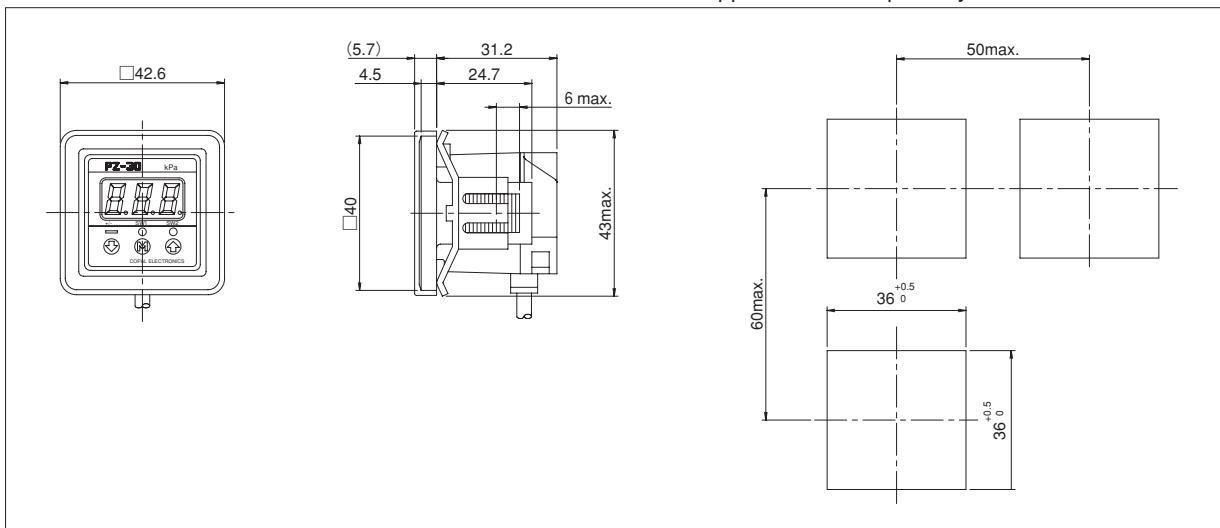

<Accessories (Sold separately)>

Panel holder set

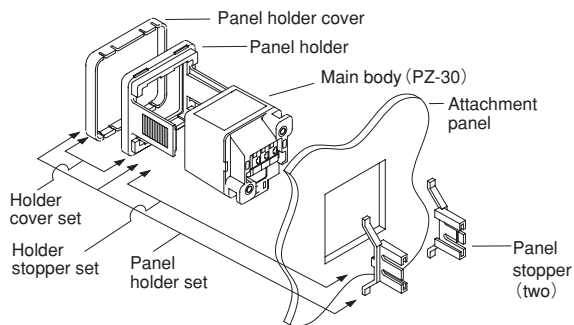

| Product name | Model no. | Description |
|-----------------------------------------------------|-----------|-------------------------------------------------------------|
| Angled bracket for wall attachment | ACPG-011 | Angled bracket for wall attachment Two M3x4 male screws |
| Angled bracket for floor attachment | ACPG-012 | Angled bracket for floor attachment Two M3x4 male screws |
| Panel holder set | ACPG-003 | Panel holder cover Panel holder Two panel stoppers |
| Holder cover set (for protection of gauge sides) | ACPG-004 | Panel holder cover Panel holder |
| Holder stopper set | ACPG-007 | Panel holder Two panel stoppers |